

Hybrid Camping Trailers

Clipper

Camping Made Easy



 **Coachmen**
Leader to the Great Outdoors.



Clipper

Setting the bar for Features, Function, Quality and Amenities is the Coachmen Clipper Camping Trailers. With sizes and models to fit the needs of all Camping Trailer enthusiasts, the Coachmen Clipper is the clear choice for Today's discriminating Camper.



Features You Can't Live Without



Sliding Storage Trunk (SST)



New E-Z One-Hand Swing Level Galley (Classics and V1)



Optional Jensen AM/FM/Bluetooth Stereo with App Control and Int./Ext. Speakers (Std. on Classics, V-Trec and Hardsides)



Exterior Utility Shelf

◀ **One-Piece Entry Door**
The Clipper's one piece entry door features an extra large privacy panel that allows for finite adjustment for air and sunlight. (N/A 806LS).



E-Z Swing Stepper Door



Optional Dometic® 3-Way Refrigerator



Dual Drive Dual Purpose Winch by Canimex

Scissor Style Stabilizer Jack



Optional Modular Cassette Potti with Electric Flush



Retractable Clothes Bar (Classics, V-Trec and Hardside)

The Clipper Difference.

Construction & Features Competitors Can't Match

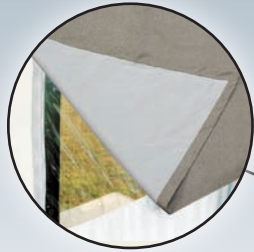

Lined drapes for improved privacy



Standard heated mattress
(Opt. on 106 & 106ST)
(N/A on LS Series)



"Glide-N-Lock" bed system is the only cable-supported bed system in the industry. Simply pull out the beds until they lock into place. No more awkward poles to contend with!

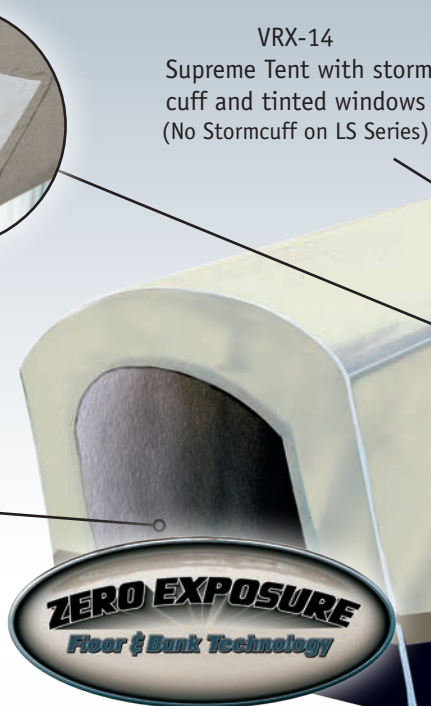

Automotive undercoat paint is applied to all floors and Polyflex woven moisture barrier laminated to all Clipper bunks vs. exposed wood used on competitive product. Another exclusive feature setting Clipper apart from the everyday Camping trailer.

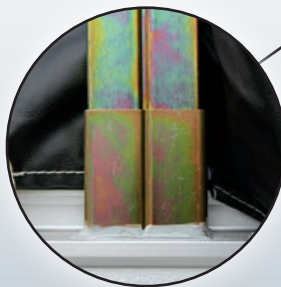

Goshen Stamping double-wide lifter post with limited lifetime warranty (N/A 806 LS)

Largest heating capacity of any folding camper.

- Optional 20M BTU Suburban® Furnace with forced air, electronic ignition and thermostat control.

VRX-14 Supreme Tent with storm cuff and tinted windows (No Stormcuff on LS Series)

Portable in/out dinette table

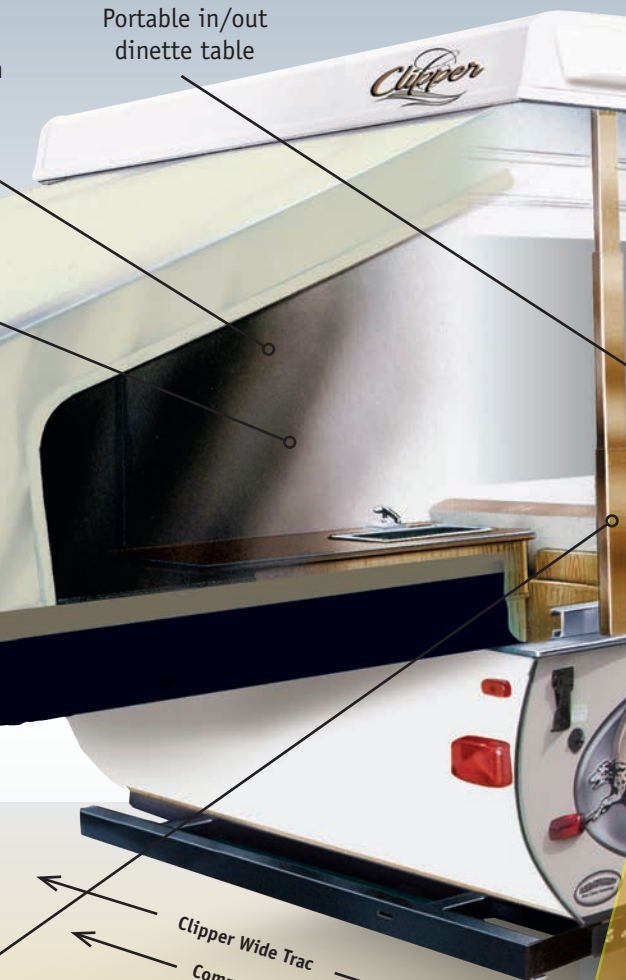

Wide Trac Suspension

Better safety and stability on the road.

- Widest stance of any folding camper
- Improves towing safety and stability
- Stronger axle beams than most competitors
- Steel frame with powdercoat protection



Dura Tuff Roof

A. One Piece Seamless Skin

B. Dura Tuff Wood Protective Layer

No one else includes the extra wood layer between the top skin and internal foam that provides stiffness and reduces the probability of damage due to hail, road debris, etc.

C. Foam Roof Structure

D. Steel Reinforced Wood Frame

The roof is framed with steel supports to accept A/C on all models without extra reinforcement.

- Roof vent is placed off to the side so the A/C can be center-mounted without having to remove the vent. This design allows you to have both the vent and A/C.

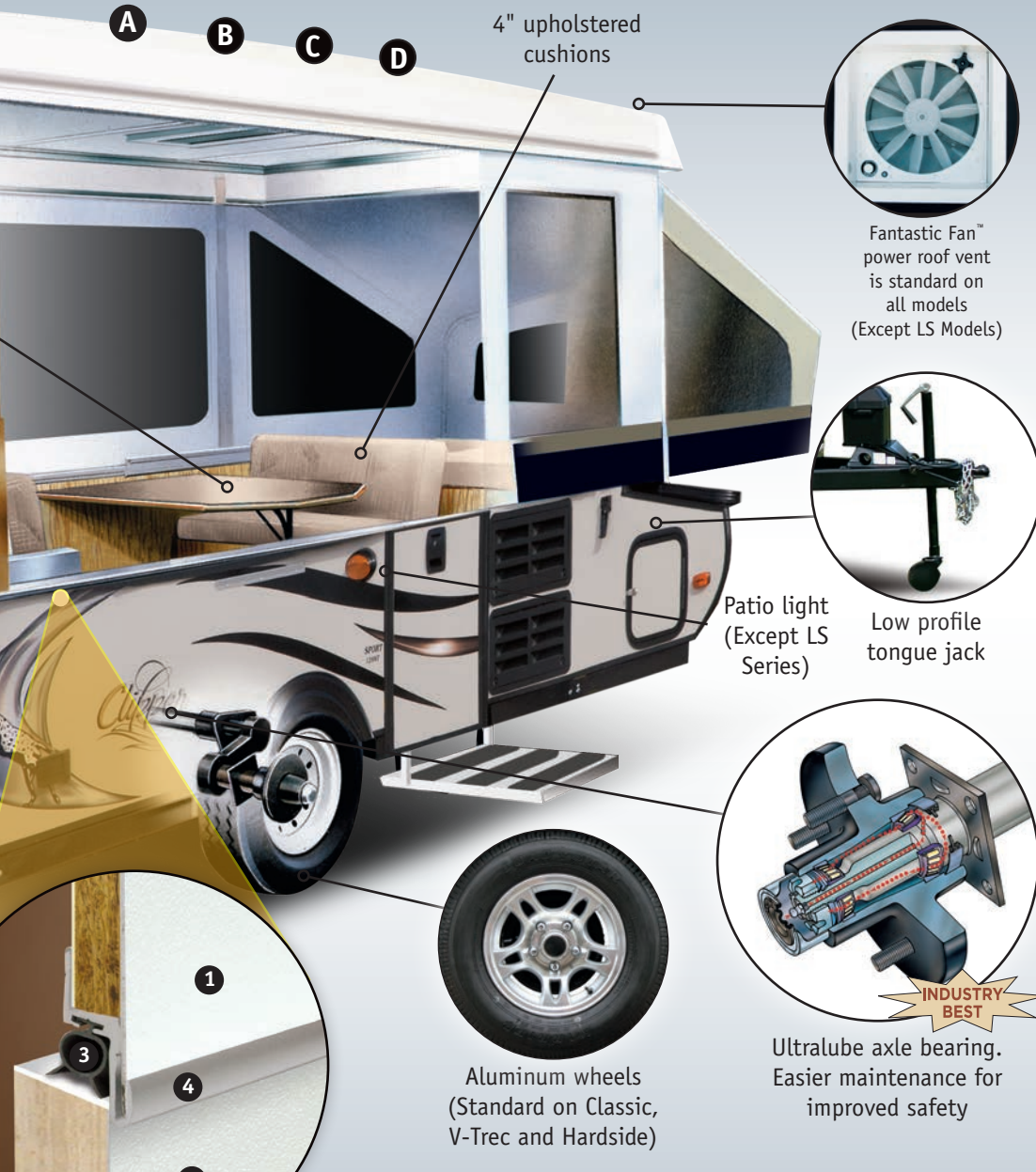

Fantastic Fan™ power roof vent is standard on all models (Except LS Models)



Low profile tongue jack

Patio light (Except LS Series)

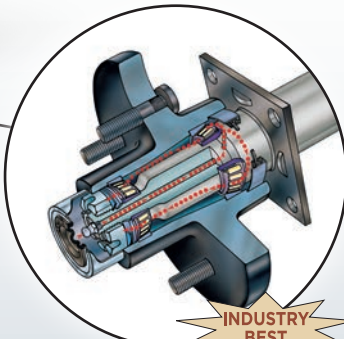

Ultralube axle bearing. Easier maintenance for improved safety

INDUSTRY BEST



Aluminum wheels (Standard on Classic, V-Trec and Hardside)

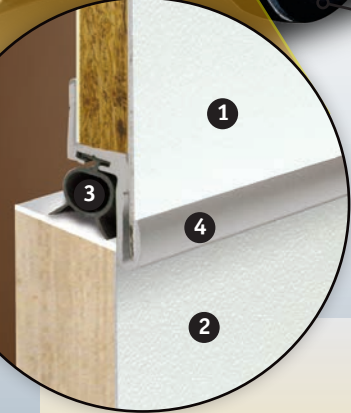

Roof Side Z-Rail Channels water away.

1. Roof's Outside Skin
2. Body's Outside Skin
3. Water tight Seal
4. Z-Rail channels water away from wood

- Z-Rails on roof perimeter and sidewalls keep wood above water level collection points.
- Others use U channel where wood and water can come in contact at the bottom of the channel.
- Channels are kept open to allow water to run out like a gutter.
- Others attempt to seal channels to keep water out; when the seal is compromised, water will collect and cannot escape.

1-1/4" Laminated Insulated Bunkend

(N/A 806 LS)

- Double the industry standard thickness
- Solid wood, steel reinforced frame filled with 1" thick high density foam and laminated with wood panel on top and bottom
- Yields a more stable bedend vs. chipboard or spliced plywood used by other brands
- Insulation improves comfort and warmth



Clipper Standard

4" E-Z Sleep Quilted Mattress

1-1/4" Laminated Insulated Bunkend

Cold Outside Air



Competition

3" Mattress

5/8" Plywood

Cold Outside Air

Clipper LS

Limited Warranty

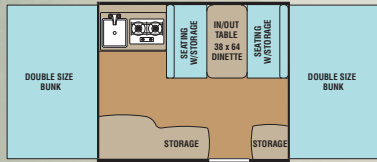

806 LS

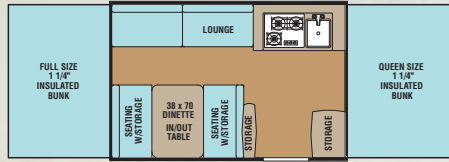

107 LS

- Lift System - Lifetime
- Vinyl Tent - 5 years
- Roll Out System - 5 years
- Frame - 5 years
- Roof Assembly - 5 years
- AL-KO® Ultralube Spring Axle - 1 year
- Refrigerator - 3 years
- Plumbing System - 10/25 years
- Electronic Converter- 2 years
- Roof Exterior - 2 years

Clipper Sport

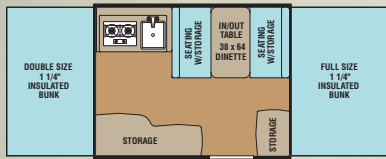

106

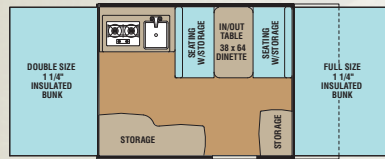

106 ST

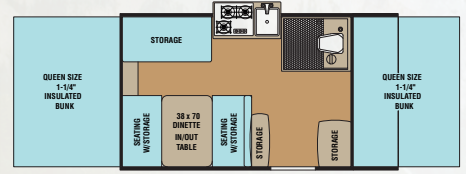

105 ST

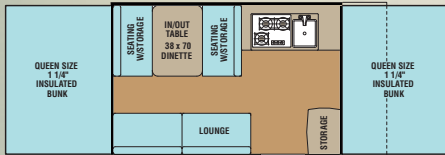

108 ST

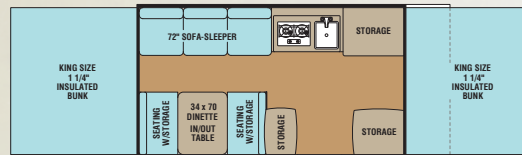

125 ST

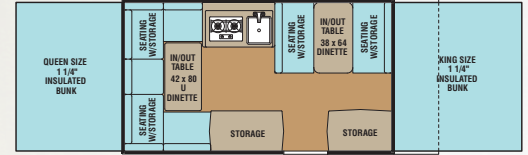

128 ST



OPTIONAL BATHROOM PACKAGE

Clipper Classic

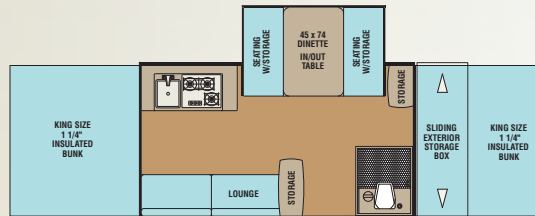

1285 SST

Clipper Hardside

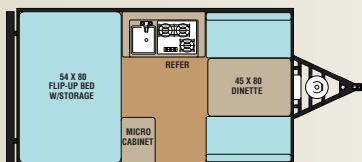

C12RB

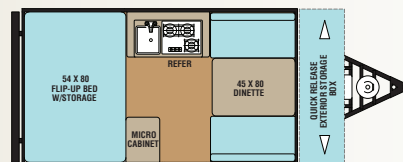

C12RBST

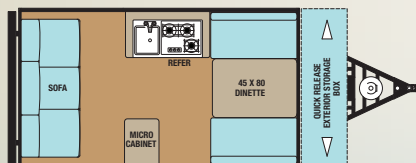

C12RSSST

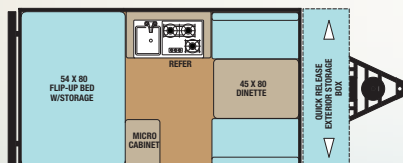

C12RBSTHW

Standard Features

	LS	S	C	H	V
CHASSIS					
Tubular Steel Frame	■	■	■	■	■
Dual Drive Winch by Canimex		■	■		■
Heavy Duty Dolly Jack with Wheel	■	■	■	■	■
Wide Trac UltraLube Spring Suspension	■	■	■		
Wide Trac Torsion Axle				■	■
Electric Brakes	■	■	■	■	■
Radial Tires		■	■	■	■
Aluminum Rims			■	■	■
Scissor Jacks with Pads (4)	■	■	■	■	■
Goshen Lift System with Double Arms (Single Arm on 806LS)	■	■	■		
EXTERIOR					
"Zero Exposure" Bunk Technology	■	■	■		■
Laminated Aluminum Skin Walls	■				
Laminated Hi-Gloss Fiberglass Walls		■	■	■	■
Laminated Hi-Gloss Gray Fiberglass Walls (V-Trec Models)					■
Diamond Plate Front Wall Protection	■	■	■	■	■
E-Z Swing Stepper Door		■	■		
One Piece Screen Door (N/A 806LS)	■	■	■		■
4 Layer Laminated Seamless Fiberglass Roof Prebraced for A/C	■	■	■		■
Exterior High Pressure LP Tank Hookup		■	■	■	■

	LS	S	C	H	V
VRX Sectionalized Tent with Storm Cuff (Storm Cuff N/A LS Series)	■	■	■		■
Laminated/Insulated Bed Platforms (N/A LS)		■	■		■
Glide-n-Lock Cable Supported Bed System	■	■	■		■
Exterior Utility Shelf		■	■	■	■
Above Floor 16 Gallon Fresh Water Tank (106, 106ST, and LS Only)	■	■			
23 Gallon Below Floor Fresh Water Tank		■	■		■
27 Gallon Below Floor Fresh Water Tank				■	■
25 AMP Converter with Battery Charger (12 AMP on LS)		■	■	■	■
120 Volt GFI Exterior Recept		■	■	■	■
Amber Patio Light		■	■	■	■
"SST" Super Sliding Storage Compartment 1285SST (Optional on V1)			■		
Removable Exterior Storage Box (C12RBST, C12RSST, C12RBSTHW)					■
Exterior Storage Access Door(s) (N/A LS, 106, 107, V1)		■	■	■	■
Create a Breeze Power Roof Vent		■	■	■	■
Tinted Safety Glass Windows					■
INTERIOR					
100% Adhesion Residential Grade Linoleum	■	■	■	■	■
Walnut Cabinetry	■	■	■	■	■
Mortise and Tenon Residential Cabinet Doors			■	■	■
Residential Laminated Countertops	■	■	■	■	■

	LS	S	C	H	V
Ultra Comfort 4" Heated Mattresses (N/A LS) (Optional 106, 106ST)		■	■	■	■
High Density Serta Mattresses					■
Ultra Comfort 4" High Density Cushions	■	■	■	■	■
Lined Privacy Drapes (Vented on Bed Ends N/A LS)		■	■	■	■
E-Z Swing Galley with Drawer				■	■
Microwave					■
Deep Bowl Acrylic Sink	■	■	■	■	■
3 Burner Range (2 Burner on 806LS, 107LS, 106, and 106ST)		■	■		■
12 Volt On Demand Water Pump	■	■	■	■	■
Built in Shower (105ST, 1285SST, and V3)		■	■	■	■
Thetford Cassette Potti (105ST, 1285SST, and V3)		■	■	■	■
DSI 6 Gallon Water Heater (105ST, 1285SST, C12RB, C12RBST, C12RSST, C12RBST HW, V1 and V3)		■	■	■	■
20,000 BTU Furnace					■
Dometic Cool Cat Heat Pump					■
Skylights with Night Shades					■
Indoor/Outdoor Dinette Table	■	■	■	■	■
12 Volt LED Interior Lights	■	■	■	■	■
120 Volt Interior Outlets	■	■	■	■	■
Retractable Clothes Bar				■	■
Powdercoated Interior Tent Support Poles	■	■	■	■	■

Popular Options

	LS	S	C	H	V
Essentials Package	■	■	■	■	■
✓ 3-Way Dometic® Refrigerator 1.9 Cu. Ft. (2.5 Cu. Ft. on Legend and V3)					
✓ 20,000 BTU Furnace					
✓ A & E Awning					
✓ Spare Tire, Carrier and Cover					
✓ 72" High Pressure LP Accessory Hose (N/A LS)					
Thetford Modular Cassette Potti with Electric Flush (108ST, 125ST, and V1)	■	■			■
DSI Hot Water System W/ Hot/Cold Exterior Shower (106ST, 107, 108ST, 1255ST and 128ST ONLY)	■	■			■

	LS	S	C	H	V
Screenroom with Privacy Flaps	■	■	■		■
Single LP Bottle Cover (N/A V1 & V3)	■	■	■		■
Double LP Bottles Rings and Cover (Std. on Hardsides, V1, and V3)		■	■		■
Hanging Storage Cabinet		■	■		■
Bed End Fan Light (1 Standard on Legend and V Trec)		■			■
Second Bed End Fan Light (N/A LS Models)	■	■			■
Ultra Comfort 4" Heated Mattresses (106, 106ST Only)		■			■
High Density Serta Mattresses		■	■		■

	LS	S	C	H	V
AM/FM/Bluetooth W/Exterior Speakers (Std. on Legend Hardside and V-Trec)		■			■
Coleman Outdoor Grill and Stand			■	■	■
SST Super Sliding Storage Trunk (V1)			■		■
Laminated High Gloss Tan Fiberglass Walls (Std. on C12RB, C12RBST, C12RSST and C12RBST HW)			■	■	
13.5M Air Conditioner		■	■	■	■
40 Watt Portable Zamp Solar Panel	■	■	■	■	■
80 Watt Portable Zamp Solar Panel	■	■	■	■	■
Bathroom Package (125ST Only)		■			■
Awning and Skirt Package					■

LS = LS Series S = Classic Sport C = Classic H = Hardside V = V-Trec

Specifications

	806 LS	107 LS	106	106 ST	105 ST	108 ST	125 ST	128 ST	1285 SST	C12RB	C12RBST	C12RSST	C12RBSTHW	V1	V3
	LS Models		Sport Series						Classic	Classic Hardside				V-Trec	
Interior Box Size:	8'	10'	8.5'	8.5'	10'	10'	12'	12'	12'	12'	12'	12'	12'	10'	12'
Travel Length:	12' 2"	14' 2"	12' 8"	14' 10"	16' 4"	16' 4"	18' 3"	18' 3"	18' 5"	16' 7"	20' 2"	20' 2"	20' 2"	16' 9"	21' 4"
Travel Width:	85"	85"	85"	85"	85"	85"	85"	85"	85"	88"	88"	88"	88"	85"	85"
Travel Height:	54"	58"	56"	56"	58"	58"	58"	58"	55"	59"	59"	59"	59"	65"	65"
Interior Open Length:	16' 11"	20' 5"	17' 11"	17' 11"	20' 9"	20' 9"	24' 5"	23' 5"	24' 5"	12'	12'	12'	12'	20' 5"	24' 5"
Interior Open Height:	6' 10"	6' 10"	6' 10"	6' 10"	6' 10"	6' 10"	6' 10"	6' 10"	6' 10"	95"	95"	95"	95"	6' 10"	6' 10"
Sleeping Capacity:	6	7	6	6	6	7	8	8	6	4	4	4	4	6	6
Front Sleeping Area:	48" x 80"	58" x 80"	54" x 80"	54" x 80"	58" x 80"	58" x 80"	70" x 80"	70" x 80"	70" x 80"	N/A	N/A	N/A	N/A	58" x 80"	70" x 80"
Rear Sleeping Area:	48" x 80"	54" x 80"	48" x 80"	48" x 80"	58" x 80"	58" x 80"	70" x 80"	58" x 80"	70" x 80"	54" x 80"	54" x 80"	N/A	54" x 80"	58" x 80"	70" x 80"
Dinette Area:	38" x 64"	38" x 70"	38" x 64"	38" x 64"	38" x 70"	38" x 70"	38" x 70"	38" x 64"	41" x 74"	45" x 80"	45" x 80"	45" x 80"	45" x 80"	38" x 70"	41" x 74"
"U" Dinette:	N/A	N/A	N/A	N/A	N/A	N/A	N/A	42" x 80"	N/A	N/A	N/A	N/A	N/A	N/A	N/A
Lounge Area:	N/A	80"	N/A	N/A	N/A	N/A	N/A	N/A	N/A	N/A	N/A	N/A	N/A	N/A	N/A
Sofa Bed:	N/A	N/A	N/A	N/A	N/A	34" x 76"	40" x 72"	N/A	N/A	N/A	N/A	40" x 72"	N/A	N/A	N/A
Radial Tire Size:	5.30X12	5.30X12	ST145R12	ST145R12	ST145R12	ST185/80R13	ST185/80R13	ST185/80R13	ST185/80R13	ST185/80R13	ST185/80R13	ST185/80R13	ST185/80R13	LT235/75R15	LT235/75R15
Tire Load Range:	5 Bolt C	5 Bolt C	5 Bolt C	5 Bolt C	5 Bolt C	5 Bolt D	5 Bolt D	5 Bolt D	5 Bolt D	5 Bolt D	5 Bolt D	5 Bolt D	5 Bolt D	5 Bolt C	5 Bolt C
Hitch Weight (Lbs./Kg.):	120/55	210/95	116/53	184/83	214/96	187/85	243/109	191/87	282/128	222/101	320/145	321/146	337/153	252/114	420/191
Axle Weight (Lbs./Kg.):	1138/51	1576/715	1338/607	1381/627	1961/883	1667/756	2083/938	1859/843	2403/1090	1724/782	1845/837	1840/835	1893/859	1981/892	2700/1225
Dry Weight (Lbs./Kg.):	1305/591	1786/810	1503/682	1651/749	2175/980	1863/845	2326/1048	2154/977	2702/1226	1946/883	2165/982	2161/980	2230/1011	2233/1013	3065/1390
Cargo Capacity (Lbs./Kg.):	778/353	514/233	813/369	733/332	526/237	824/374	1120/505	1257/570	800/363	1662/754	1453/659	1546/701	1439/677	1519/689	1325/601
GVWR (Lbs./Kg.):	2098/952	2300/1043	2096/951	2200/999	2718/1224	2702/1227	3463/1560	3464/1571	3502/1588	3642/1652	3635/1649	3741/1697	3757/1704	3994/1799	4380/1987
Coupler Size:	2"	2"	2"	2"	2"	2"	2"	2"	2"	2"	2"	2"	2"	2-5/16"	2-5/16"

*Weights shown are approximate. †Estimated Average based on standard build optional equipment. All weights shown are in Pounds/Kilograms.

V-Trec

Heavier Duty Than Other Folding Campers!

Specs | V1 V3

Interior Box Size	10'	12'
Travel Length	16'9"	21' 4"
Travel Width	85"	85"
Travel Height	65"	65"
Interior Open Length	20'5"	24' 5"
Interior Open Height	6' 10"	6' 10"
Sleeping Capacity	6	6
Front Sleeping Area	58 X 80	70 X 80
Rear Sleeping Area	58 X 80	70 X 80
Dinette Area	38 X 70	41 X 74
"U" Dinette	N/A	N/A
Lounge Area	N/A	N/A
Sofa Bed	N/A	N/A
Radial Tire Size	LT235/75R15	LT235/75R15
Tire Load Range	5 Bolt C	5 Bolt C
Hitch Weight # (approx.), (lbs./Kg)	252/114	420/191
Unloaded Vehicle Weight†	2233/1013	3065/1390
Cargo Carrying Capacity‡	1519/689	1325/601
GVWR (lbs./Kg)	3994/1799	4380/1987
Coupler Ball Size	2-5/16"	2-5/16"

† Estimated Average based on standard build optional equipment.
All weights shown are in Pounds/Kilograms.



V1

- 5" Tube Frame
- Reinforced Diamond Plate Front Deck
- 4000 Lb. Heavy Duty Leaf Spring Axle for Heavy Cargo Capacity

V-Trec Series

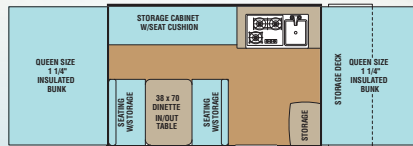

V1

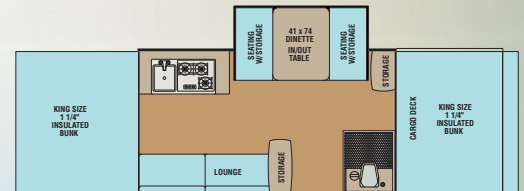

V3

Coachmen Recreational Vehicles A Forest River Company

580 West Burr Oak Street
P.O. Box 549
Centreville, MI 49032
269.467.6321

To learn more about Coachmen RV and our products and see how Coachmen is making the easy life easier, visit www.coachmenrv.com.



Free Roadside Assistance

Coachmen provides one year of free Travel Easy™ emergency roadside assistance for those who buy a new Coachmen RV. Administered by Coach-Net®, this service gives Coachmen owners 24/7 access to operational, technical and emergency road services, including towing, fuel delivery, jump starts, lockout service, tire changes, mobile mechanic and unlimited technical advice. So no matter where you go, we're ready to help!



Big Benefits For New Owners

Owners club discounts and more — A free one-year membership in the Coachmen Owners Association comes with the purchase of any Coachmen product. This add-on value not only provides a host of travel services and campground discounts, but also a 24/7 online service that locates needed services while offering member savings at more than 180,000 merchants across the country. And, of course, the COA is an excellent way to share experiences with other Coachmen owners through rallies and caravans.



Forest River, Inc. encourages our customers to purchase their Forest River products from a local dealership whenever possible for the following reasons:

- 1) Forest River, Inc. dealers are independently owned and operated businesses so priority service and scheduling is at their discretion and is often provided to customers that purchased their unit at that dealership.
- 2) Purchasing locally allows customers to establish meaningful relationships with a dealer, enhancing the RV experience through assistance with product questions, user tips or RV regulations for your state or country, and much more!
- 3) Canadian customers must meet requirements to bring an RV purchased out of the country to their home. These requirements may involve additional inspections and certifications, taxes and fees. Your local Canadian Dealer is a professional at meeting these requirements.
- 4) Scheduling timely warranty repairs and adjustments through a local dealership provides far greater flexibility and convenience to you, the customer!

It is the goal of Forest River, Inc. that all of our RV owners fully enjoy the RV experience and that customer satisfaction meets or exceeds their expectations!



Learn More
Scan this barcode using a QR Reader on your smart phone to learn more about Forest River.



A Berkshire Hathaway company.

Contact your Clipper Dealer for a complete list of parts and accessories: